

# Dual Sheer Shades From Rollergy®

---

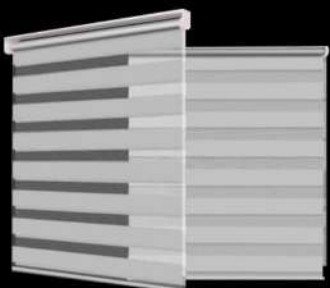

ROLLERGY

— DUAL SHEER SHADES —

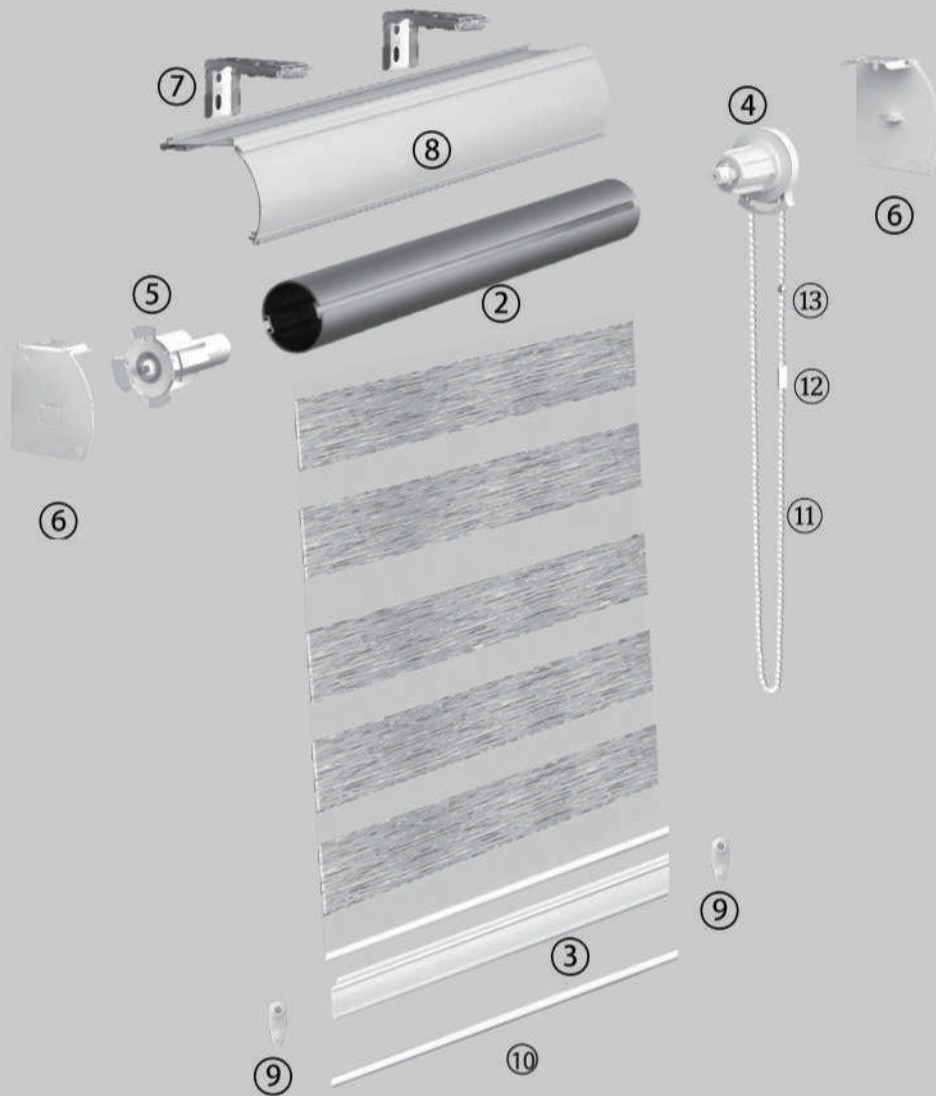

**STANDARD COMPONENTS**

- |  |                        |
|--|------------------------|
| ① Fabric                                   | ⑪ Bead Chain           |
| ② Roller Tube Dimensions :<br>DG38----38mm | ⑫ Bead Chain Connector |
| ③ Hem Bar                                  | ⑬ Bead Chain Stop      |
| ④ Clutch                                   |                        |
| ⑤ End Plug                                 |                        |
| ⑥ Front Fascia End Cap                     |                        |
| ⑦ Front Fascia Bracket                     |                        |
| ⑧ Front Fascia                             |                        |
| ⑨ Hem Bar end cap                          |                        |
| ⑩ Round Tube                               |                        |

— WAND DUAL SHEER SHADES —

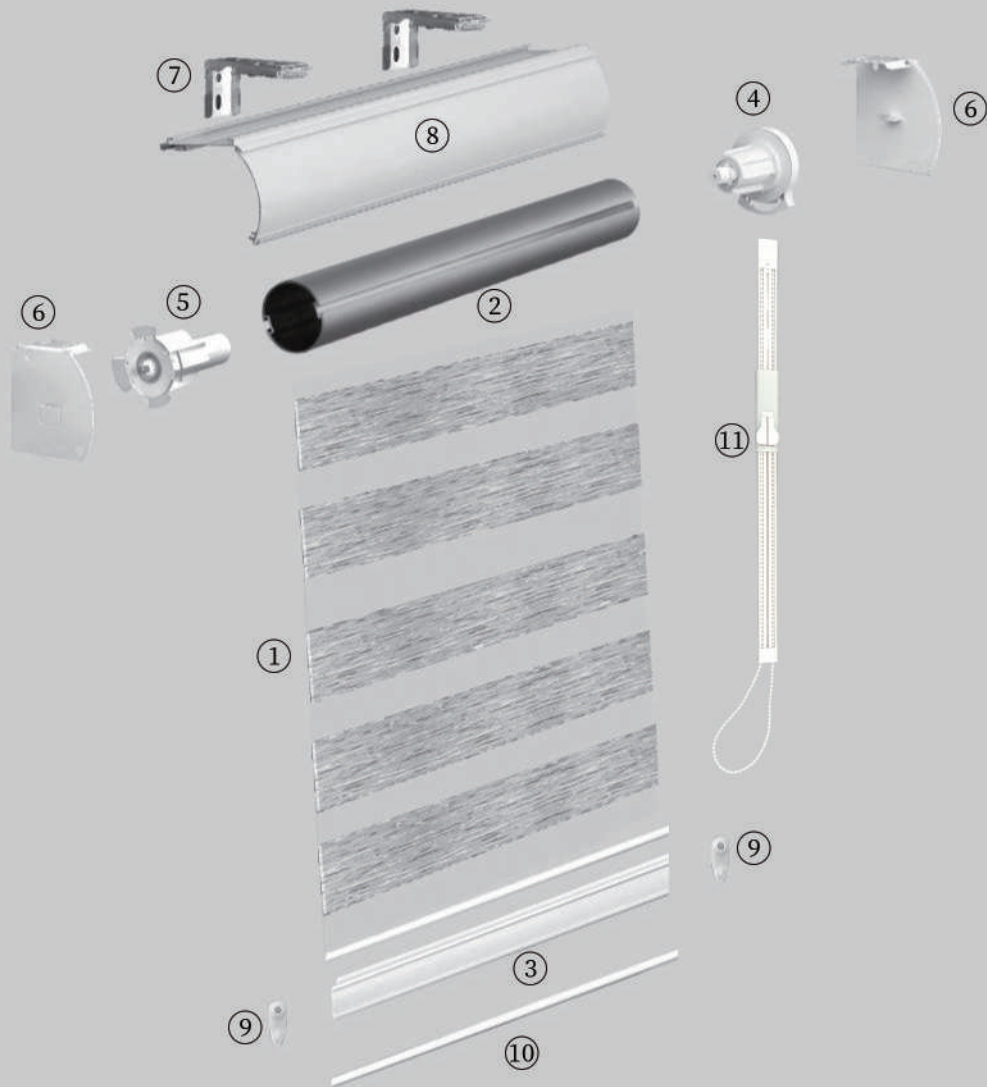

**STANDARD COMPONENTS**

- ① Fabric
- ② Roller Tube Dimensions :  
DG38----38mm
- ③ Hem Bar
- ④ Clutch
- ⑤ End Plug
- ⑥ Front Fascia End Cap
- ⑦ Front Fascia Bracket
- ⑧ Front Fascia
- ⑨ Hem Bar end cap
- ⑩ Round Tube
- ⑪ Wand

— **MOTORIZED DUAL SHEER SHADES** —

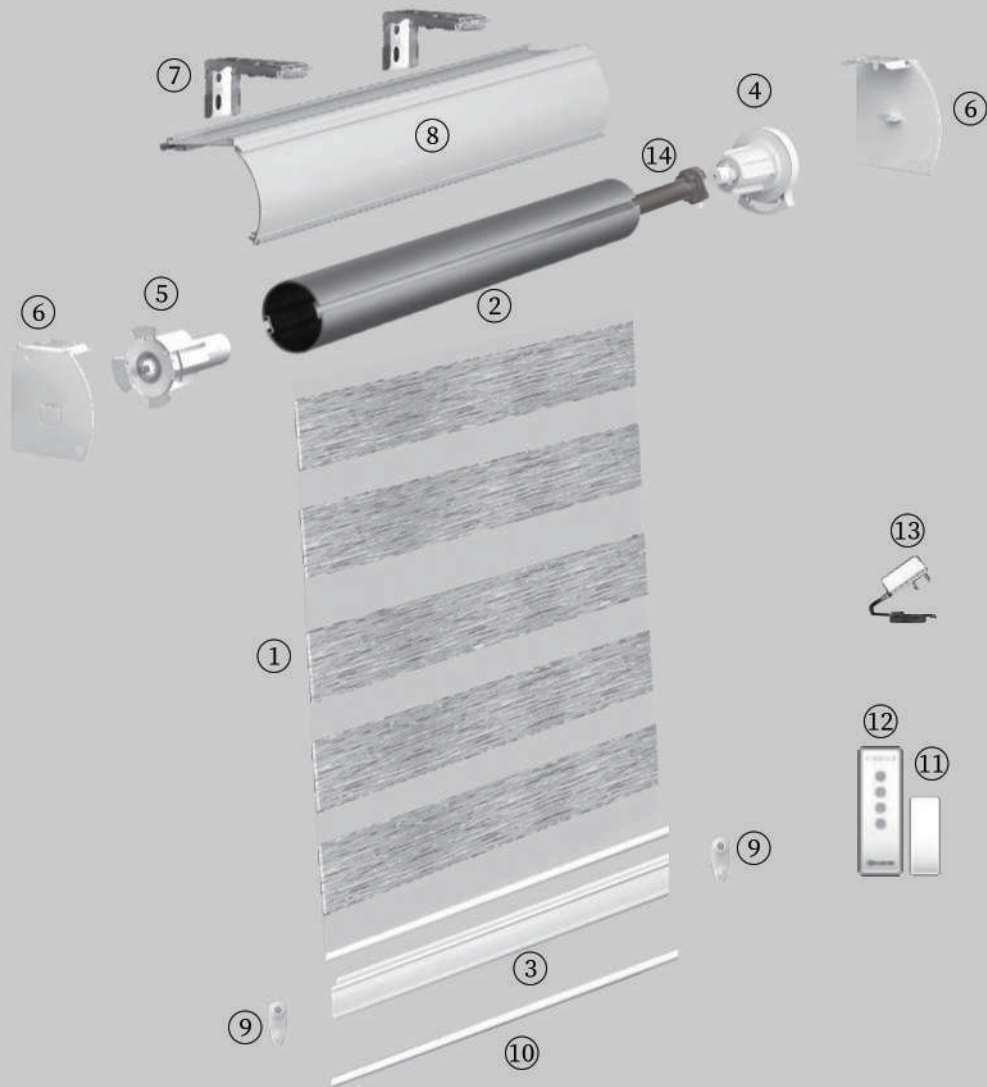

**STANDARD COMPONENTS**

- |  |                       |
|--|-----------------------|
| ① Fabric                                   | ⑪ Remote Control Base |
| ② Roller Tube Dimensions :<br>DG38----38mm | ⑫ Remote Control      |
| ③ Hem Bar                                  | ⑬ Charger             |
| ④ Clutch                                   | ⑭ Motor               |
| ⑤ End Plug                                 |                       |
| ⑥ Front Fascia End Cap                     |                       |
| ⑦ Front Fascia Bracket                     |                       |
| ⑧ Front Fascia                             |                       |
| ⑨ Hem Bar end cap                          |                       |
| ⑩ Round Tube                               |                       |

— SPRING DUAL SHEER SHADES —

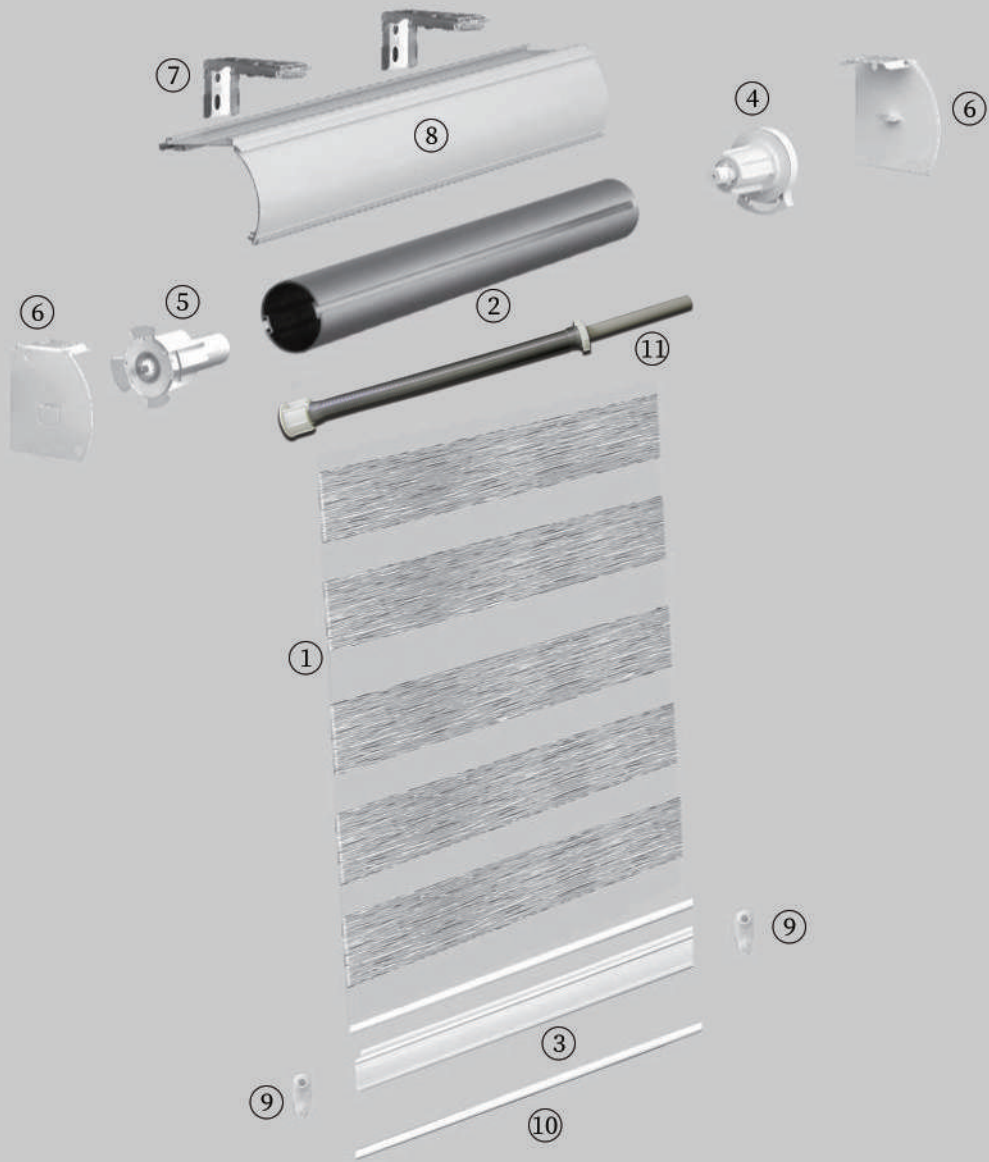

**STANDARD COMPONENTS**

- ① Fabric
- ② Roller Tube Dimensions :  
DG38----38mm
- ③ Hem Bar
- ④ Clutch
- ⑤ End Plug
- ⑥ Front Fascia End Cap
- ⑦ Front Fascia Bracket
- ⑧ Front Fascia
- ⑨ Hem Bar end cap
- ⑩ Round Tube
- ⑪ Spring

**DIMENSIONS CHARTS**

**38mm Tube Alum. Tube with Cassette  
( 100% Polyester Translucent Fabric )**

MIN WIDTH/HEIGHT	MAX WIDTH	MAX HEIGHT	MAX AREA	PELMET WIDTH
300/500mm	2300mm	3000mm	6m <sup>2</sup>	≥ 100mm(cm)

**38mm Tube Alum. Tube with Cassette  
( 100% Polyester Room-darkening Fabric )**

MIN WIDTH/HEIGHT	MAX WIDTH	MAX HEIGHT	MAX AREA	PELMET WIDTH
300/500mm	2300mm	2600mm	5.5m <sup>2</sup>	≥ 100mm(cm)

**38mm Tube Alum. Tube with Cassette  
( PVC+ Polyester Sunscreen Fabric )**

MIN WIDTH/HEIGHT	MAX WIDTH	MAX HEIGHT	MAX AREA	PELMET WIDTH
300/500mm	2300mm	1800mm	4m <sup>2</sup>	≥ 100mm(cm)

**38mm Tube Alum. Tube with Cassette  
( 100% Polyester Translucent Fabric )**

MIN WIDTH/HEIGHT	MAX WIDTH	MAX HEIGHT	MAX AREA	PELMET WIDTH
300/500mm	2300mm	3000mm	6m <sup>2</sup>	≥ 100mm(cm)

**38mm Tube Alum. Tube with Cassette  
( 100% Polyester Room-darkening Fabric )**

MIN WIDTH/HEIGHT	MAX WIDTH	MAX HEIGHT	MAX AREA	PELMET WIDTH
300/500mm	2300mm	2600mm	5.5m <sup>2</sup>	≥ 100mm(cm)

**DIMENSIONS CHARTS**

**38mm Tube Alum. Tube with Cassette  
( PVC+ Polyester Sunscreen Fabric )**

MIN WIDTH/HEIGHT	MAX WIDTH	MAX HEIGHT	MAX AREA	PELMET WIDTH
300/500mm	2300mm	1800mm	4m <sup>2</sup>	≥ 100mm(cm)

**38mm Tube Alum. Tube with Cassette  
( 100% Polyester Translucent Fabric ) - 25mm Diameter Motor**

MIN WIDTH/HEIGHT	MAX WIDTH	MAX HEIGHT	MAX AREA	PELMET WIDTH
550/500mm	2300mm	3000mm	6m <sup>2</sup>	≥ 100mm(cm)

**38mm Tube Alum. Tube with Cassette  
( 100% Polyester Room-darkening Fabric ) - 25mm Diameter Motor**

MIN WIDTH/HEIGHT	MAX WIDTH	MAX HEIGHT	MAX AREA	PELMET WIDTH
550/500mm	2300mm	2600mm	5.5m <sup>2</sup>	≥ 100mm(cm)

**38mm Tube Alum. Tube with Cassette  
( PVC+ Polyester Sunscreen Fabric ) - 25mm Diameter Motor**

MIN WIDTH/HEIGHT	MAX WIDTH	MAX HEIGHT	MAX AREA	PELMET WIDTH
550/500mm	2300mm	1800mm	4m <sup>2</sup>	≥ 100mm(cm)

## Room Darkening

Apricot

DS-RD-BL-2001

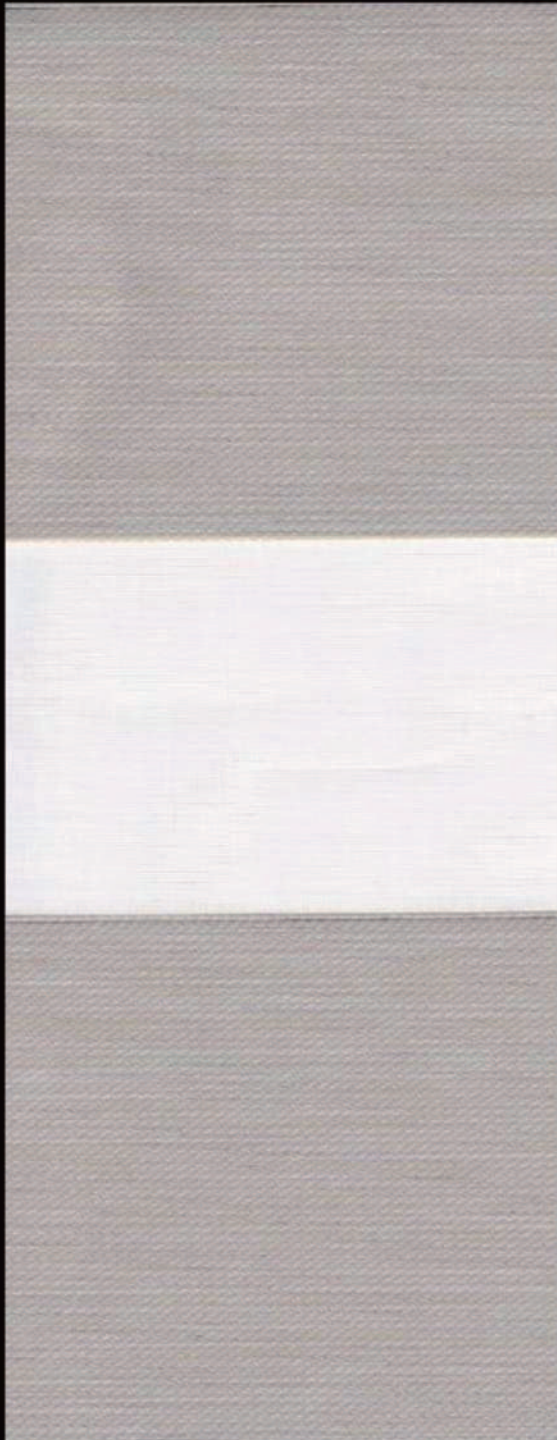

## Room Darkening

Taupe

DS-RD-BL-2002





## Room Darkening

Camel

DS-RD-BL-2003



## Room Darkening

Silvery

DS-RD-BL-2004



## Room Darkening

Glacier

DS-RD-BL-2005

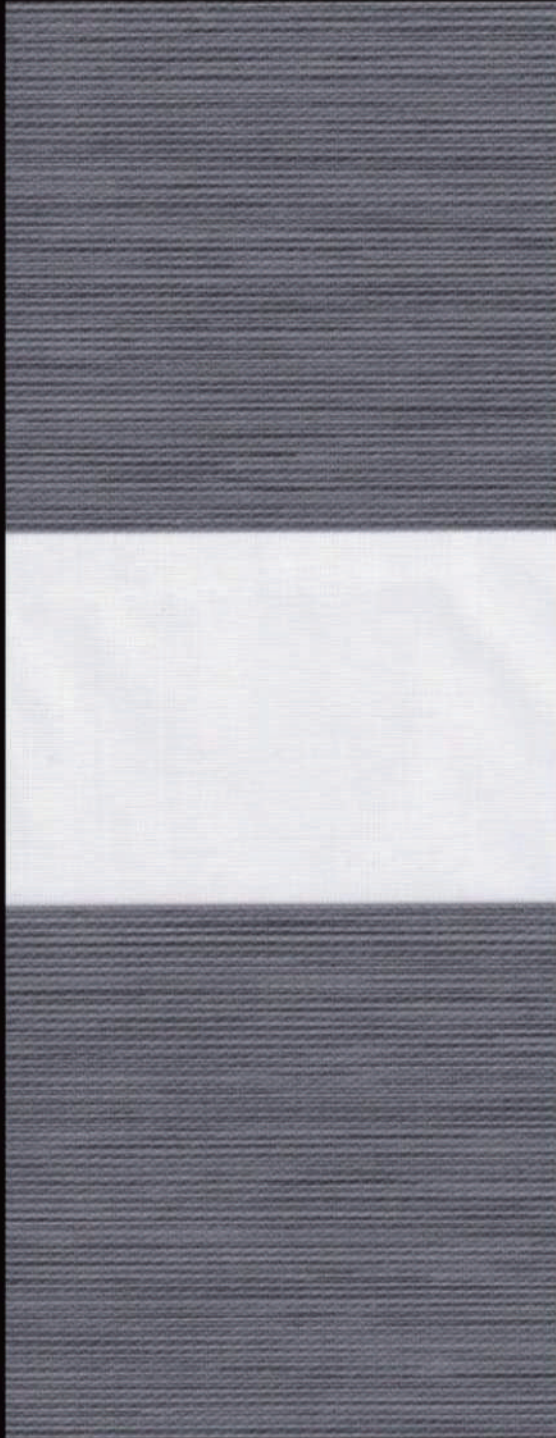

## ROOM DARKENING

G35-001

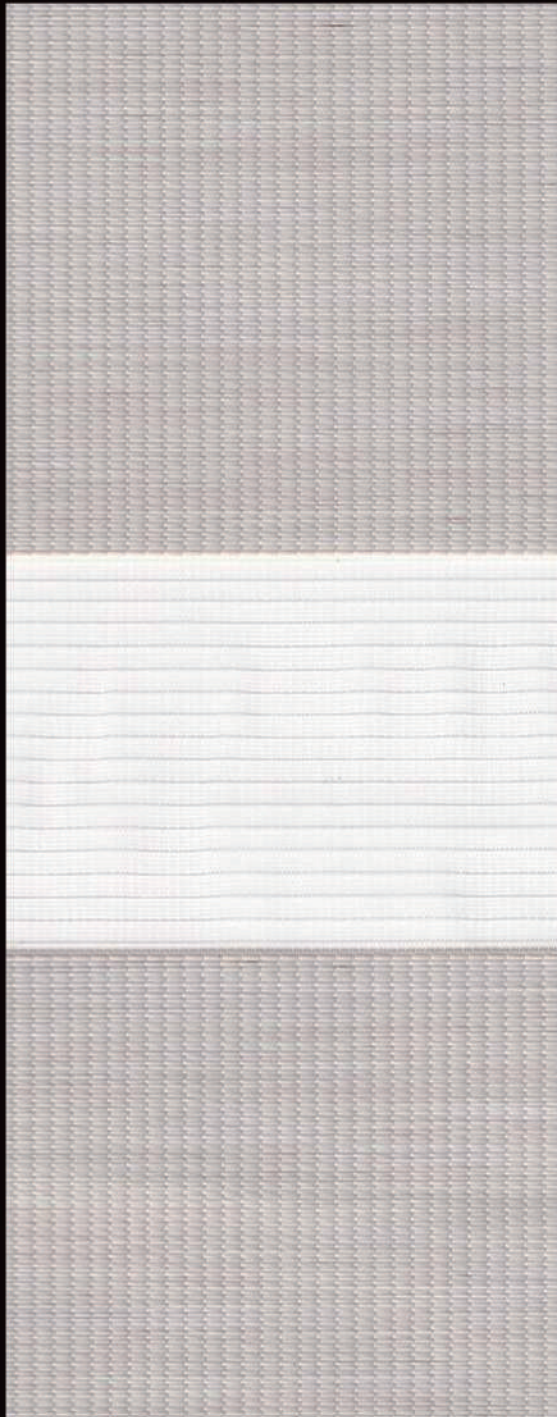

## ROOM DARKENING

G35-002



## ROOM DARKENING

G35-003

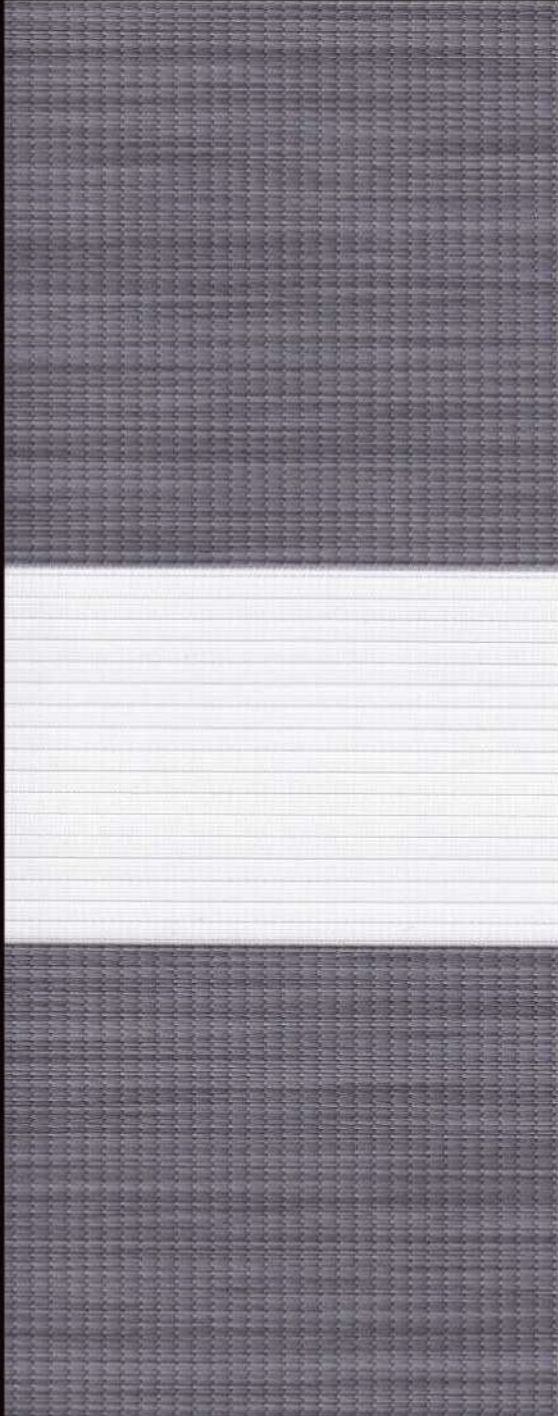

## ROOM DARKENING

G35-004



## TRANSLUCENT

F124-1

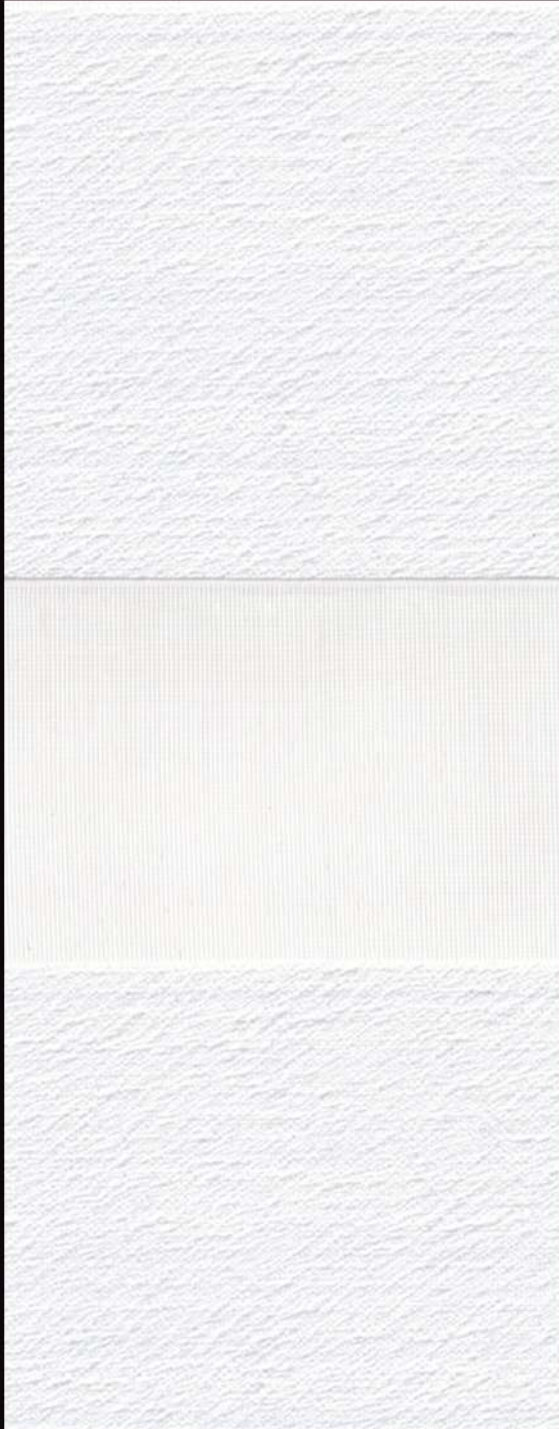

## TRANSLUCENT

F124-2



## TRANSLUCENT

F124-3



## TRANSLUCENT

F124-4



## TRANSLUCENT

F124-5



## TRANSLUCENT

F124-6



# TRANSLUCENT

F167-1



# TRANSLUCENT

F167-2

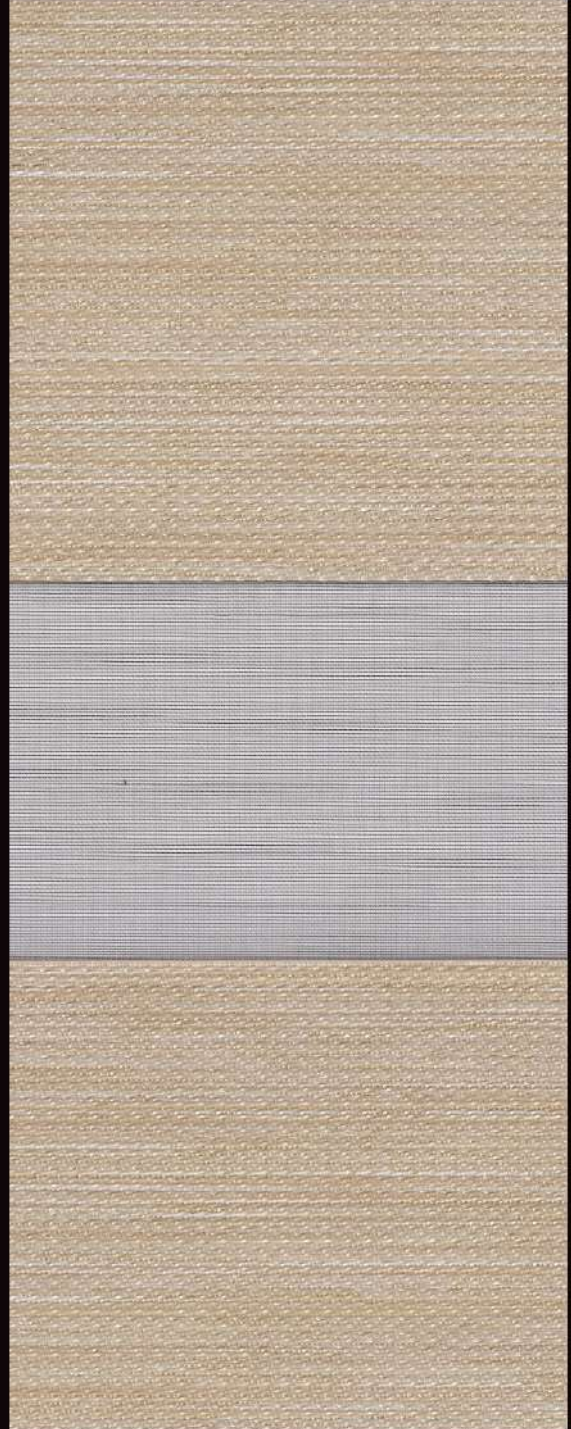



# TRANSLUCENT

F167-3

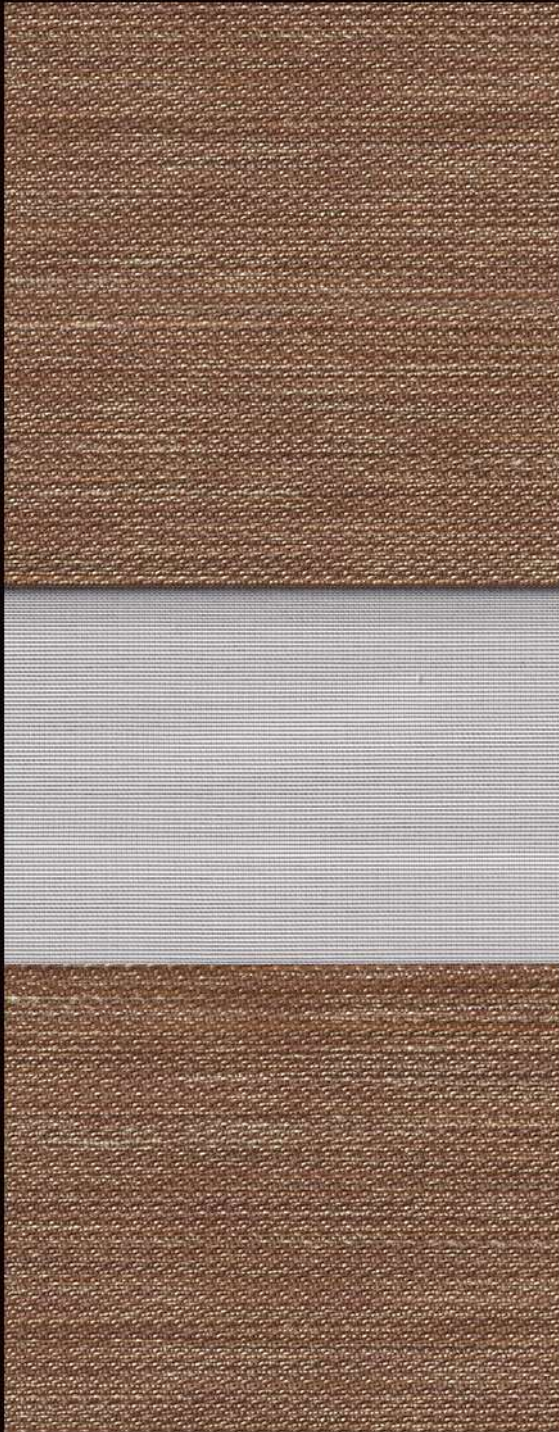

# TRANSLUCENT

F167-4



# TRANSLUCENT

F167-5



# TRANSLUCENT

F167-6



# TRANSLUCENT

F167-7



# TRANSLUCENT

F167-8

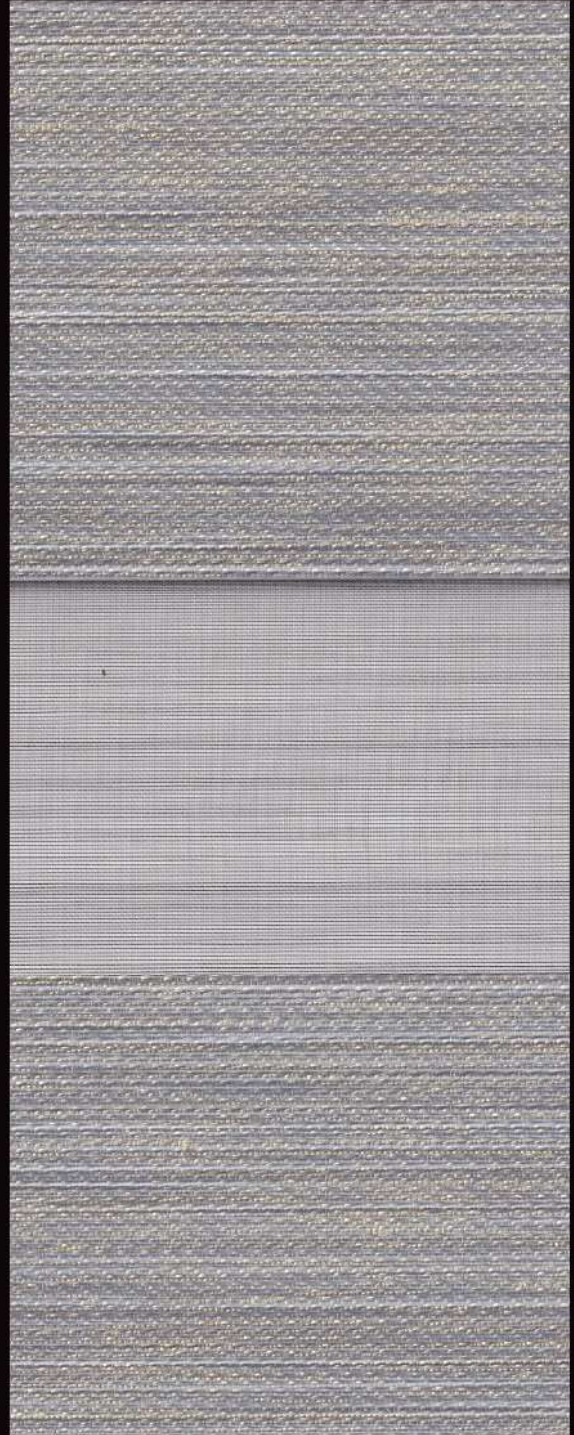

# TRANSLUCENT

F167-9

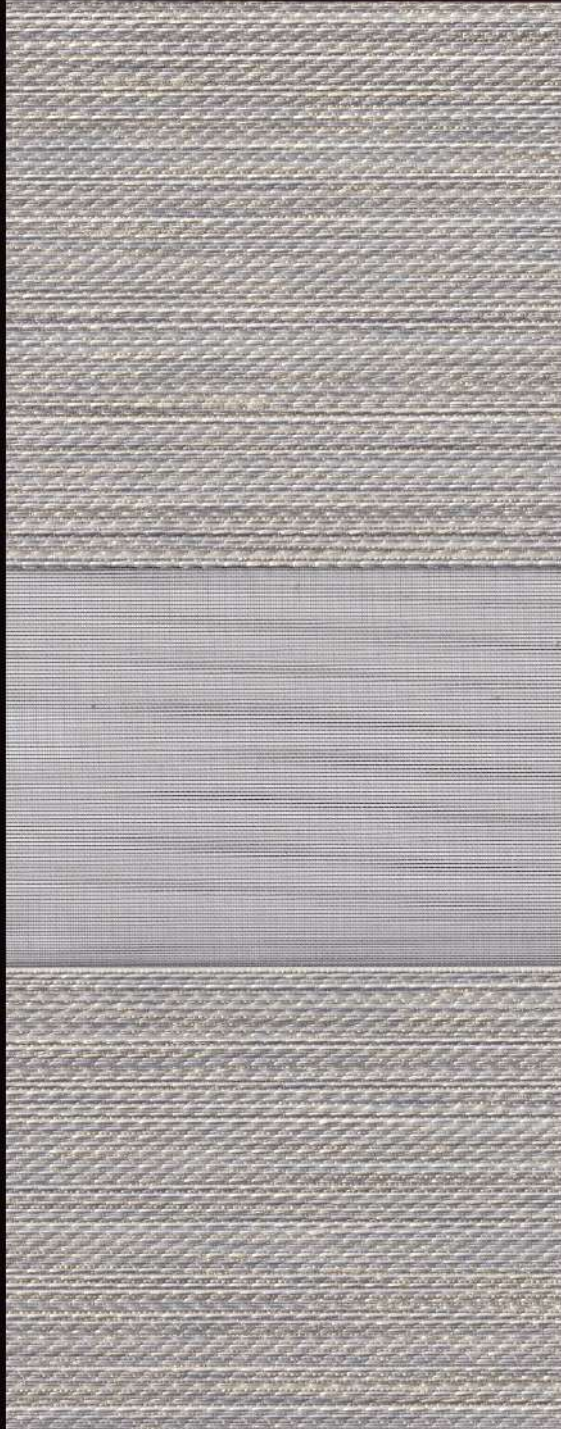

Translucent

White

DS-TR-G31-001



Translucent

Cream

DS-TR-G31-003



Translucent

Pearl

DS-TR-G31-004

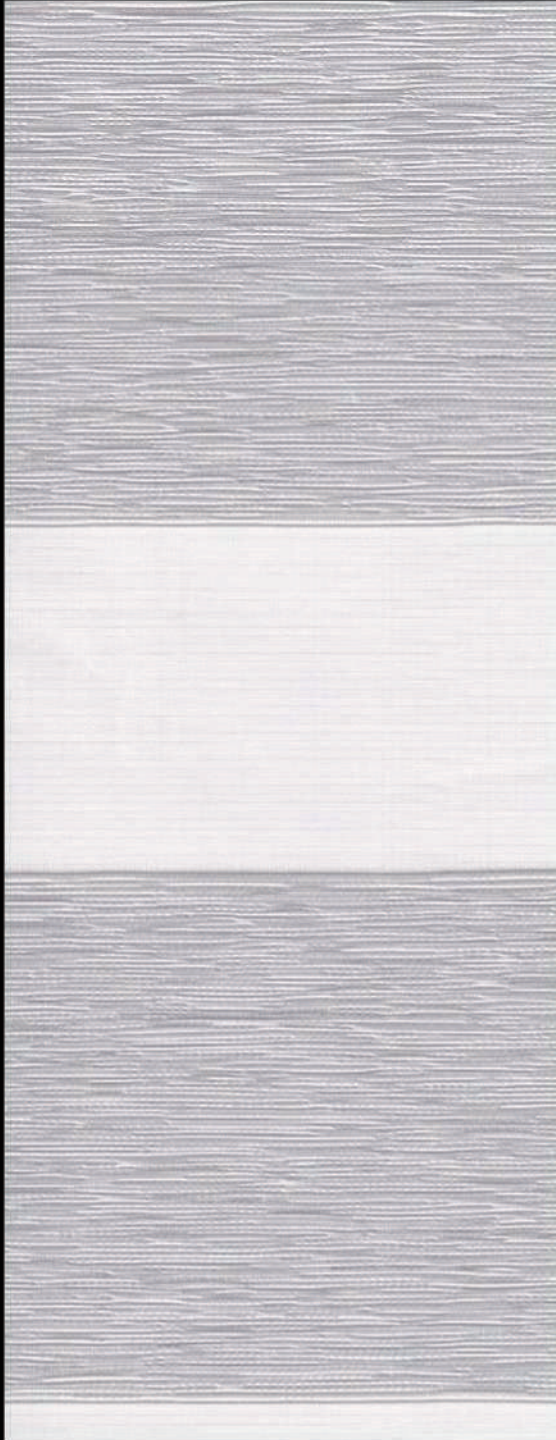

Translucent

Black

DS-TR-G31-005

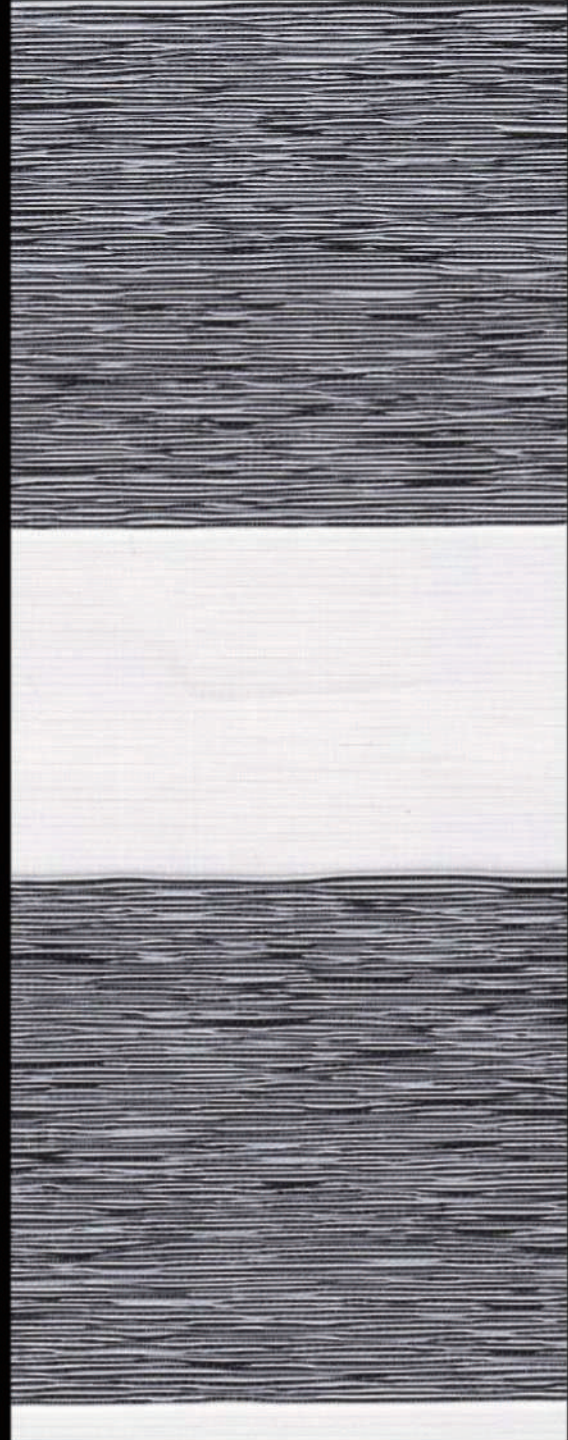

# TRANSLUCENT

G32-001

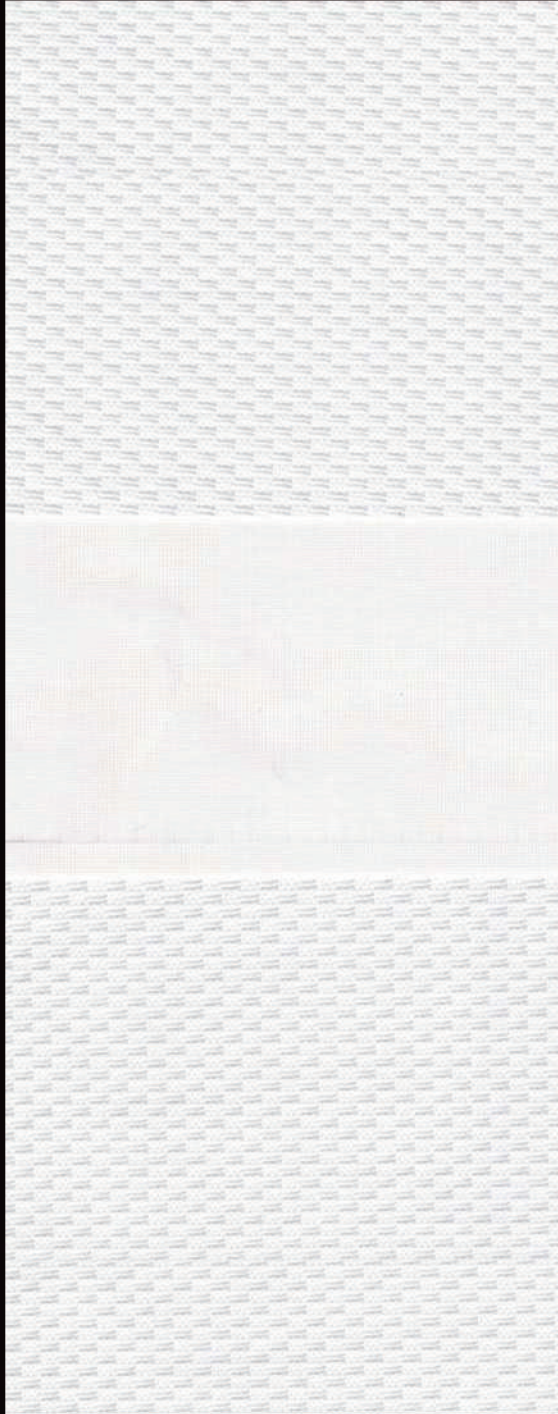

# TRANSLUCENT

G32-002

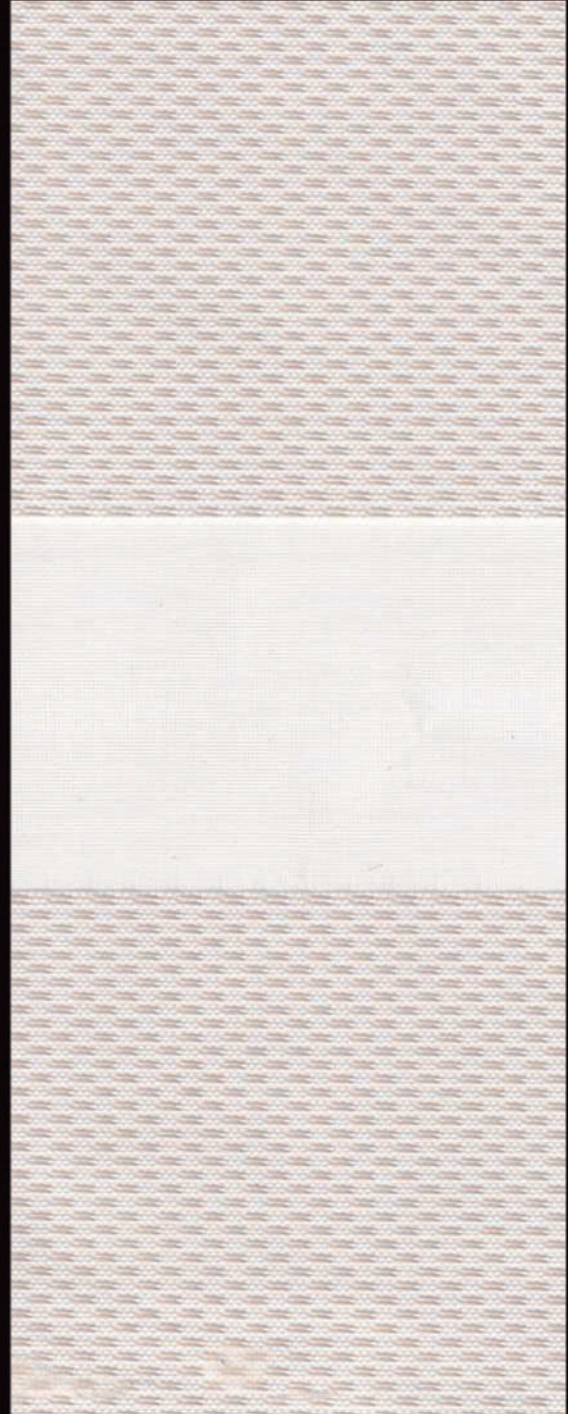

# TRANSLUCENT

G32-003

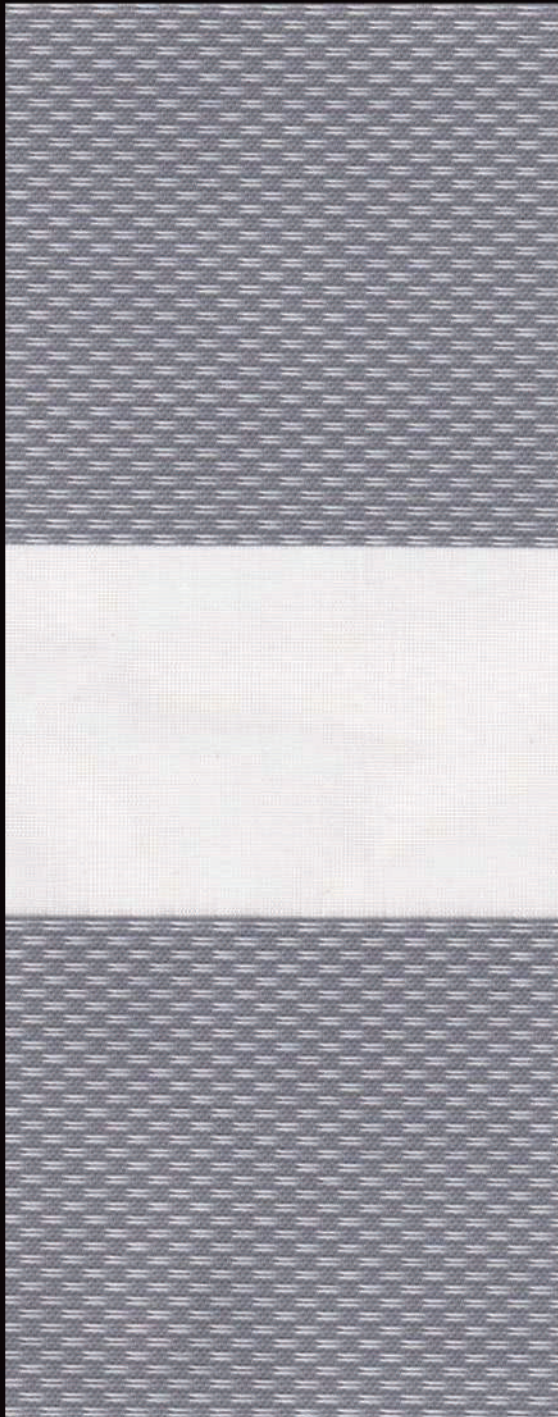

# TRANSLUCENT

G32-004

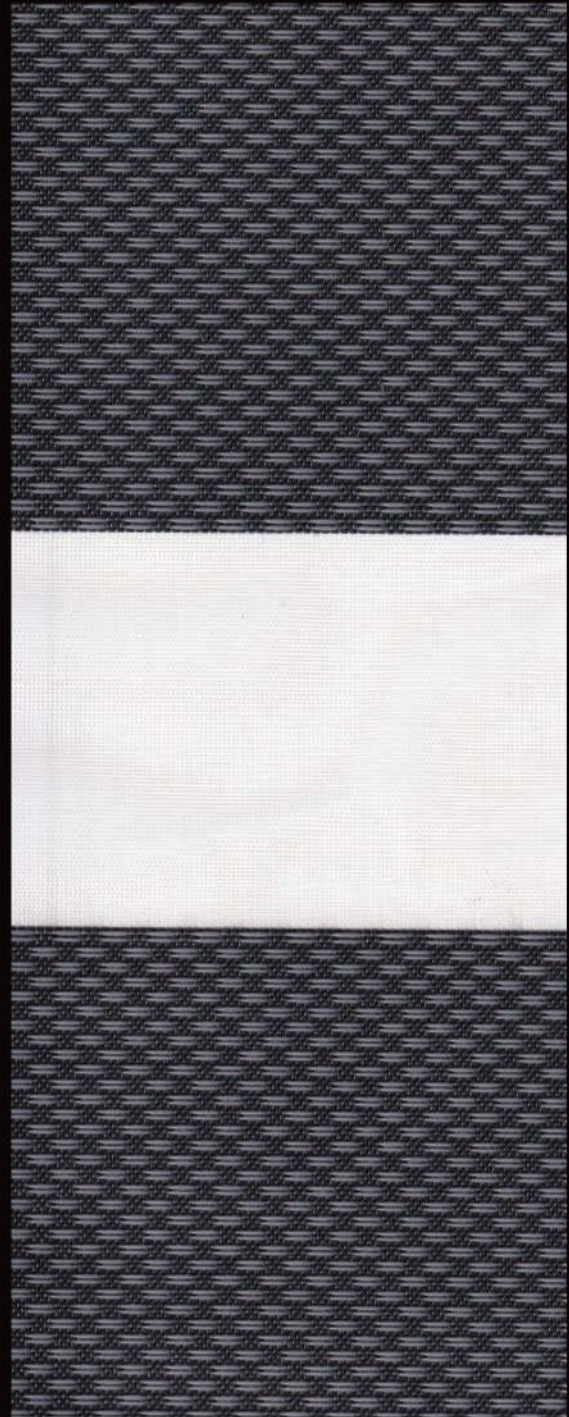



## TRANSLUCENT

G36-001

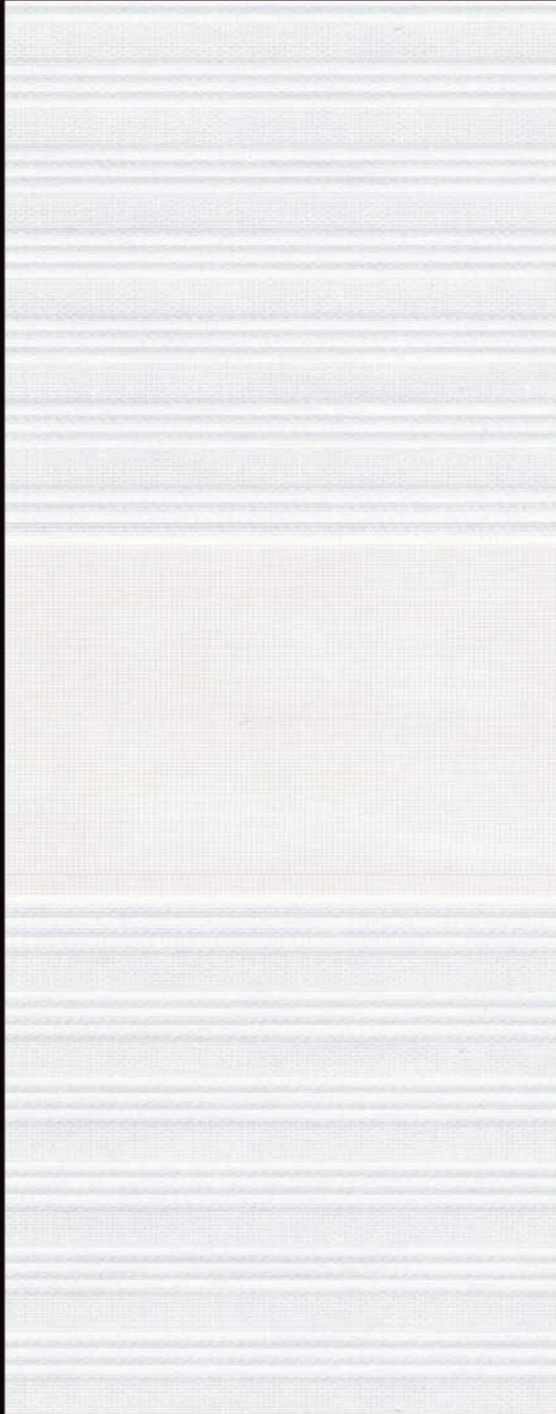

## TRANSLUCENT

G36-002

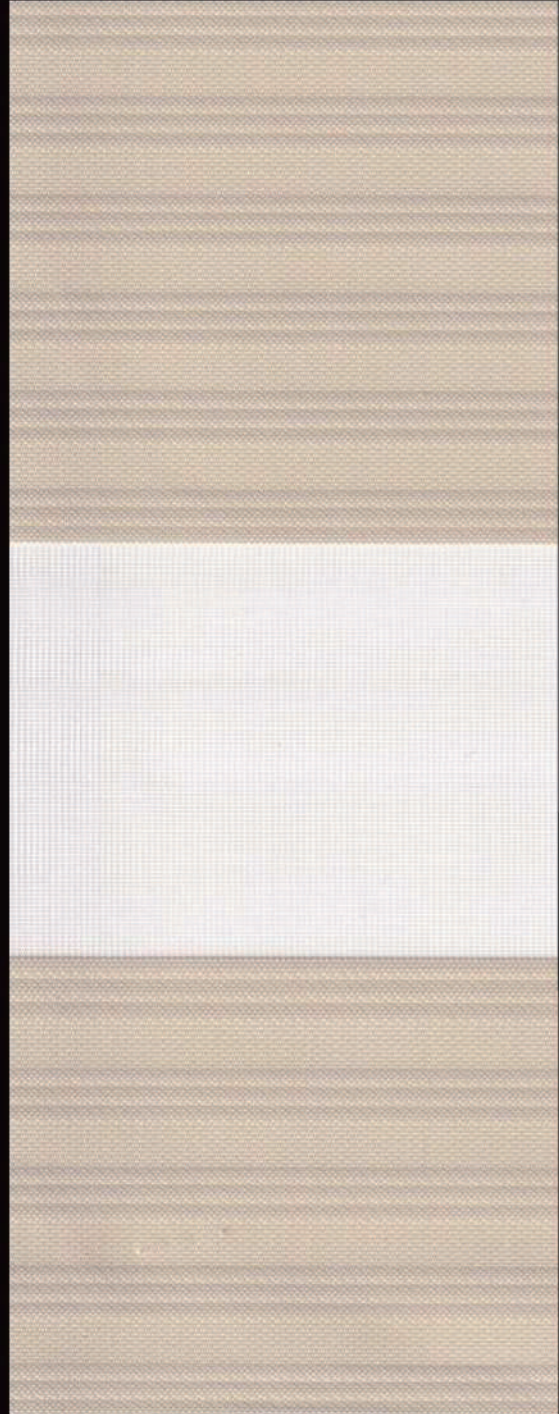

## TRANSLUCENT

G36-003

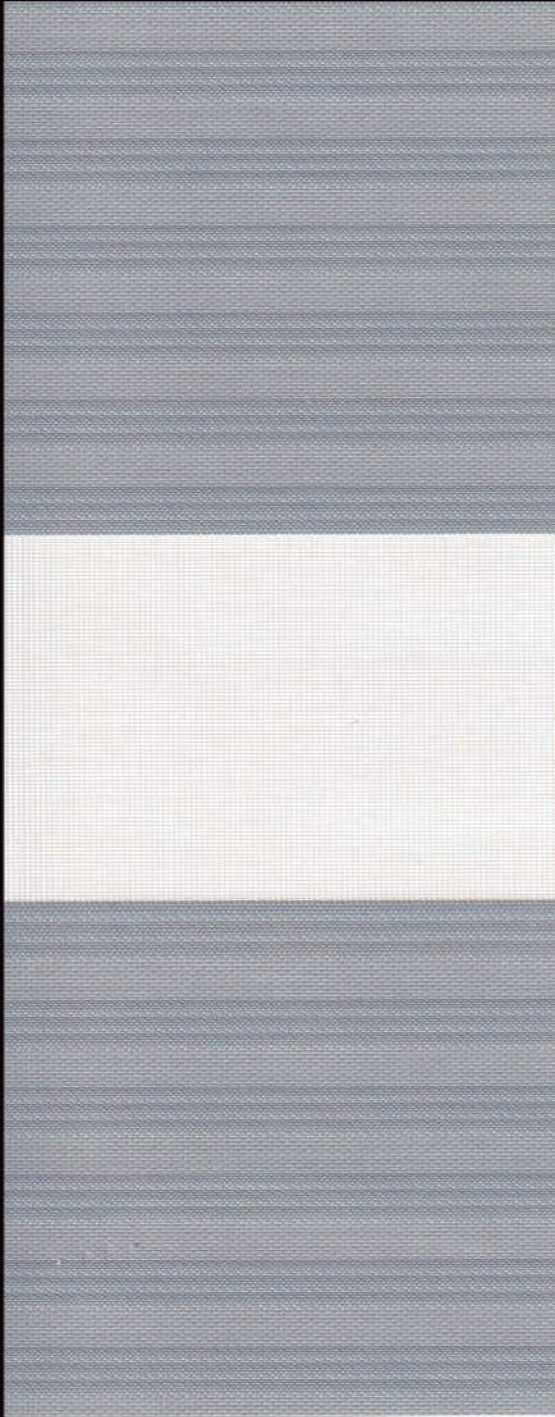

## TRANSLUCENT

G36-004



# TRANSLUCENT

G37-001



# TRANSLUCENT

G37-002



# TRANSLUCENT

G37-003

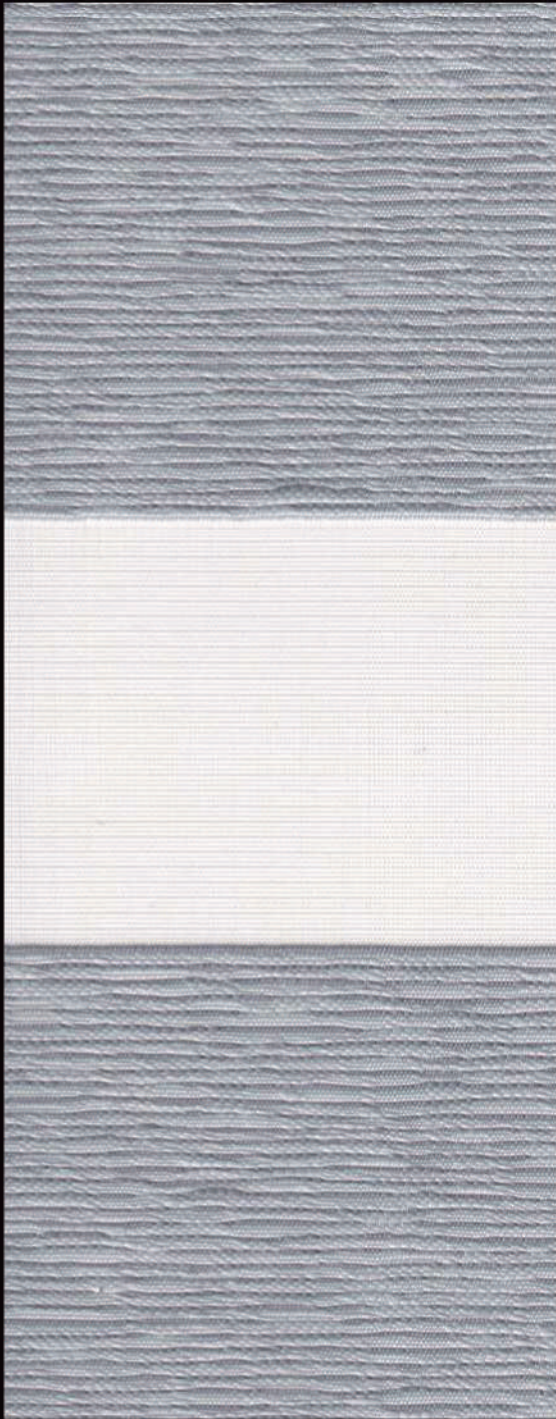

# TRANSLUCENT

G37-004



# TRANSLUCENT

G37-005

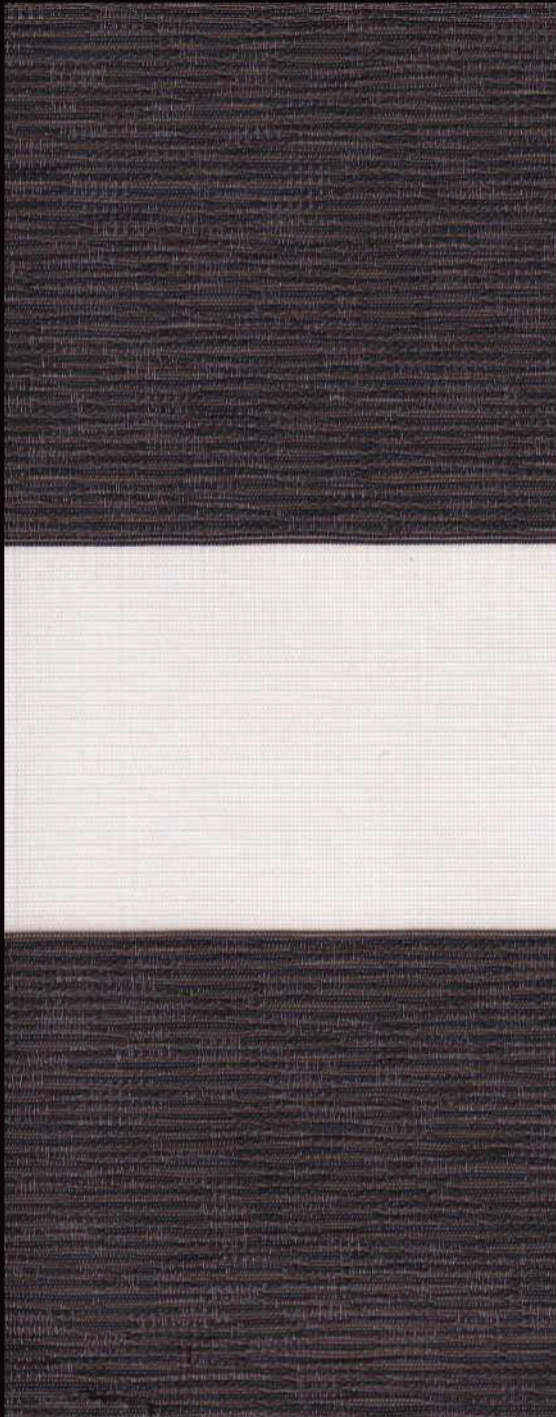

# TRANSLUCENT

G38-001

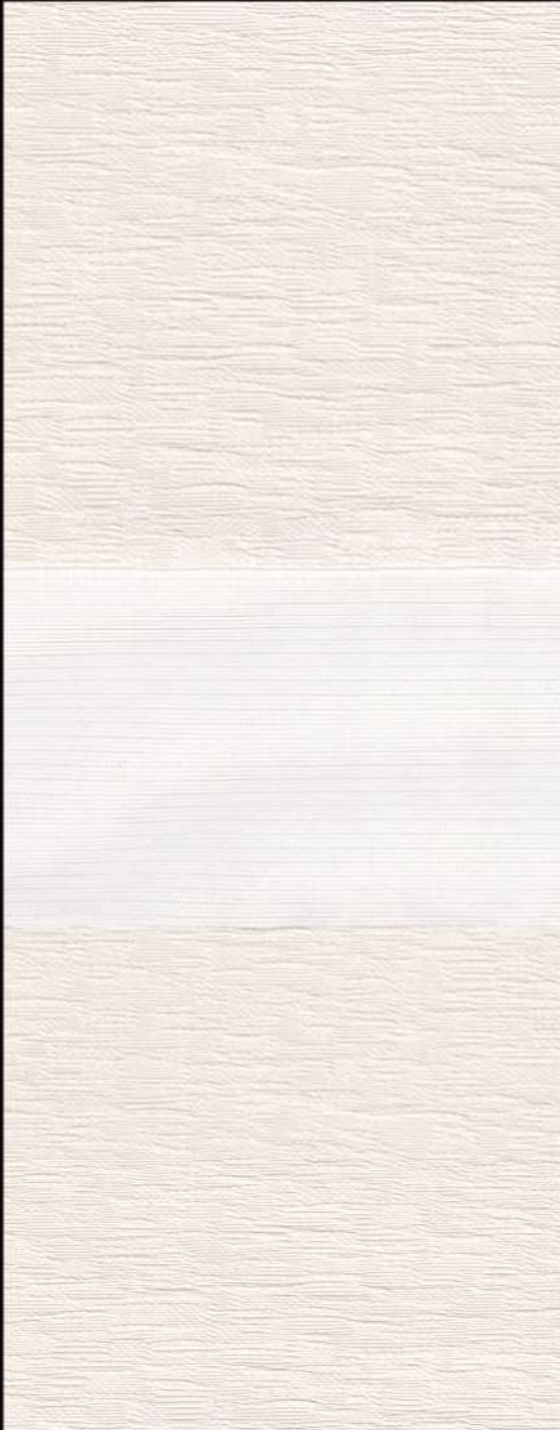

# TRANSLUCENT

G38-002

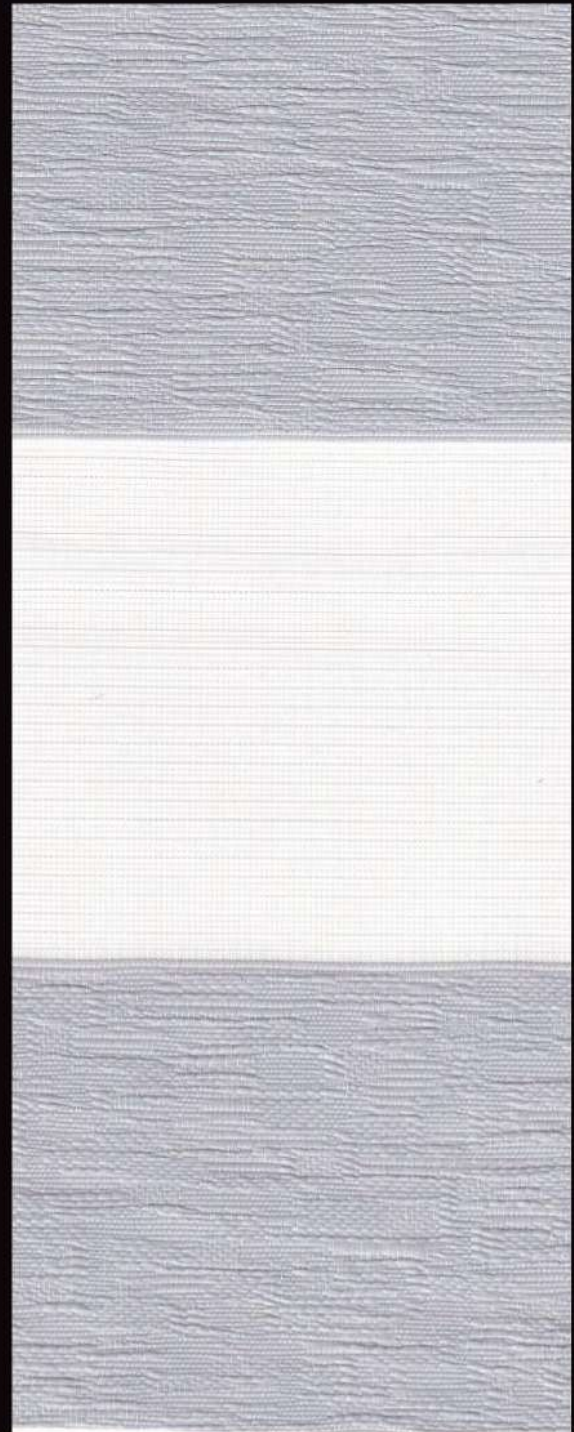

# TRANSLUCENT

G38-003

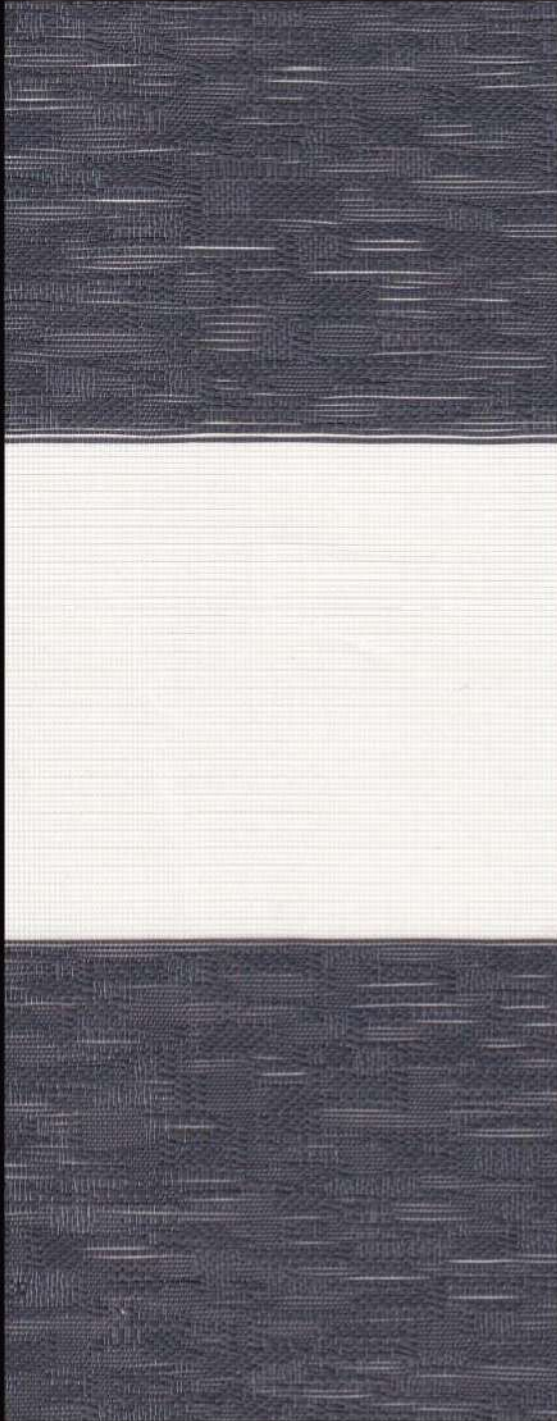

# TRANSLUCENT

G38-004



# TRANSLUCENT

G.38-005

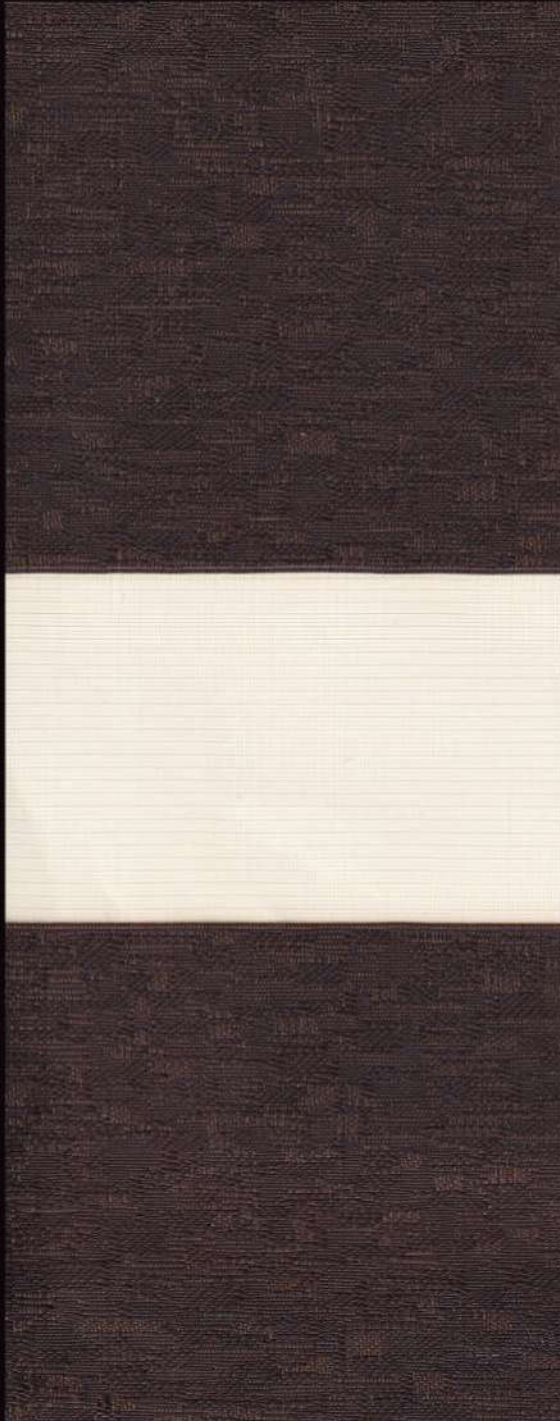



Zebra-Screen

white\*White

DS-ZE-0101

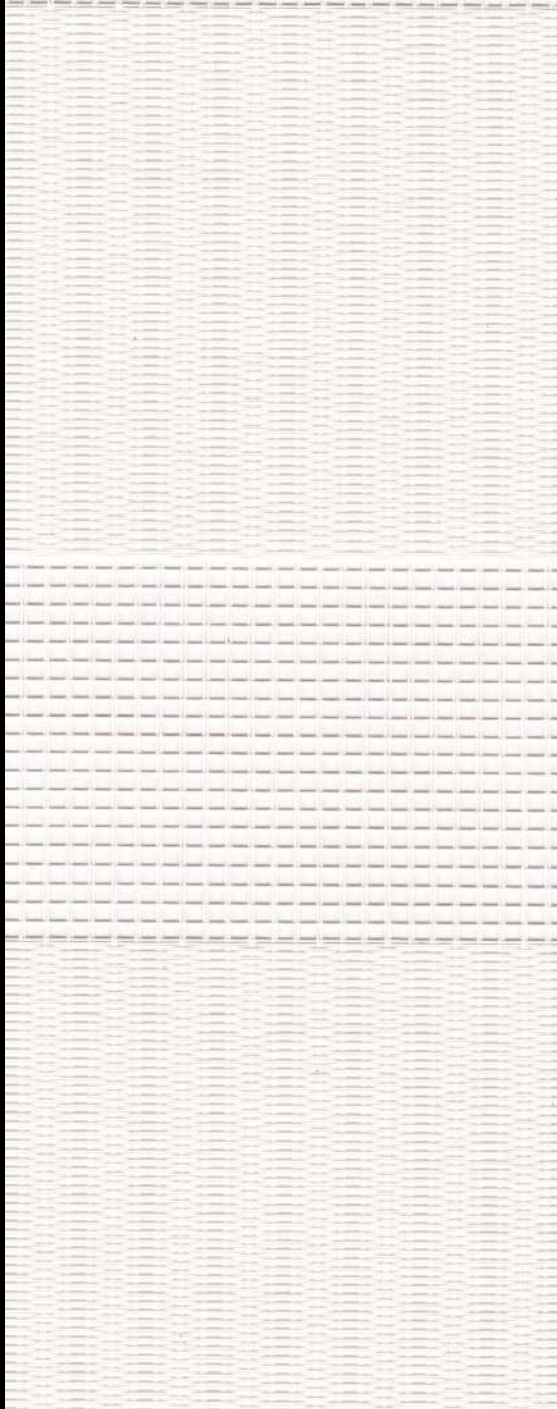

Zebra-Screen

White \* Linen

DS-ZE-0102

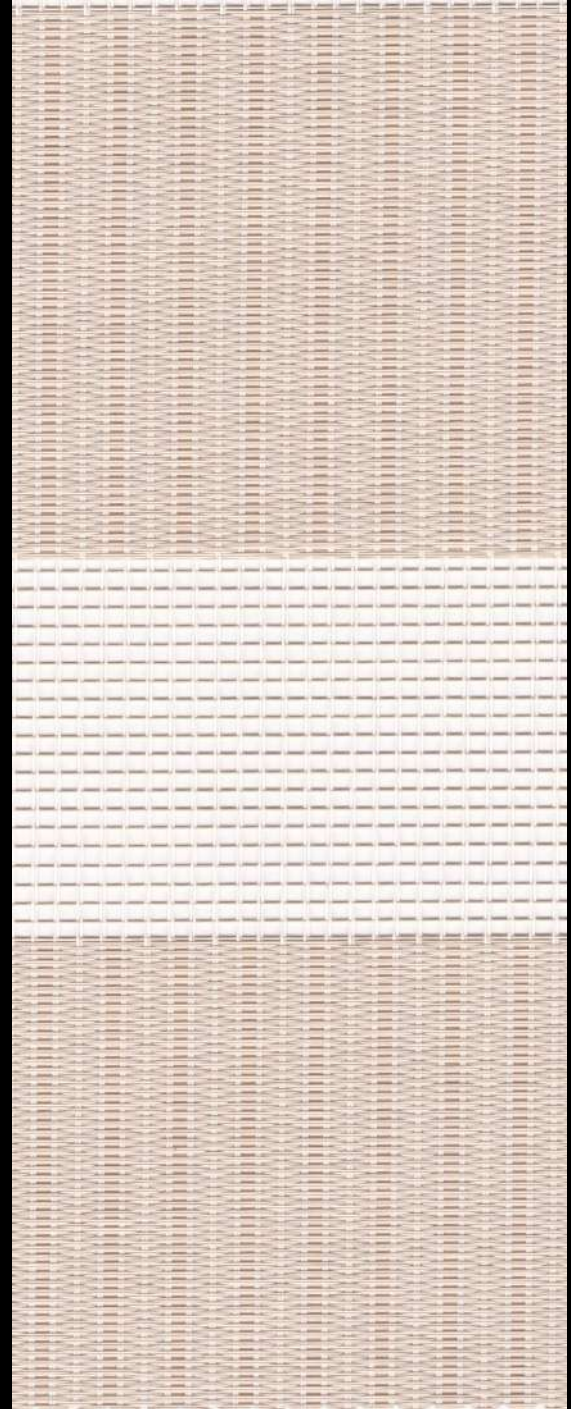

## Zebra-Screen

white \* Grey

DS-ZE-0105

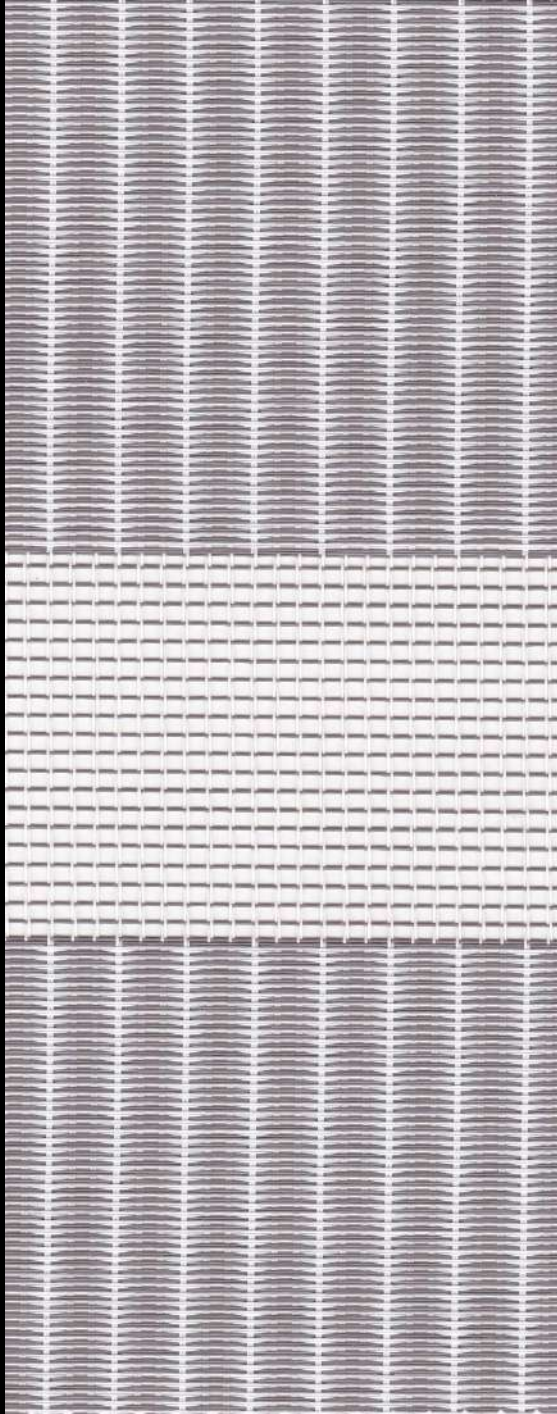

## Zebra-Screen

White/Linen\* Linen

DS-ZE-0313

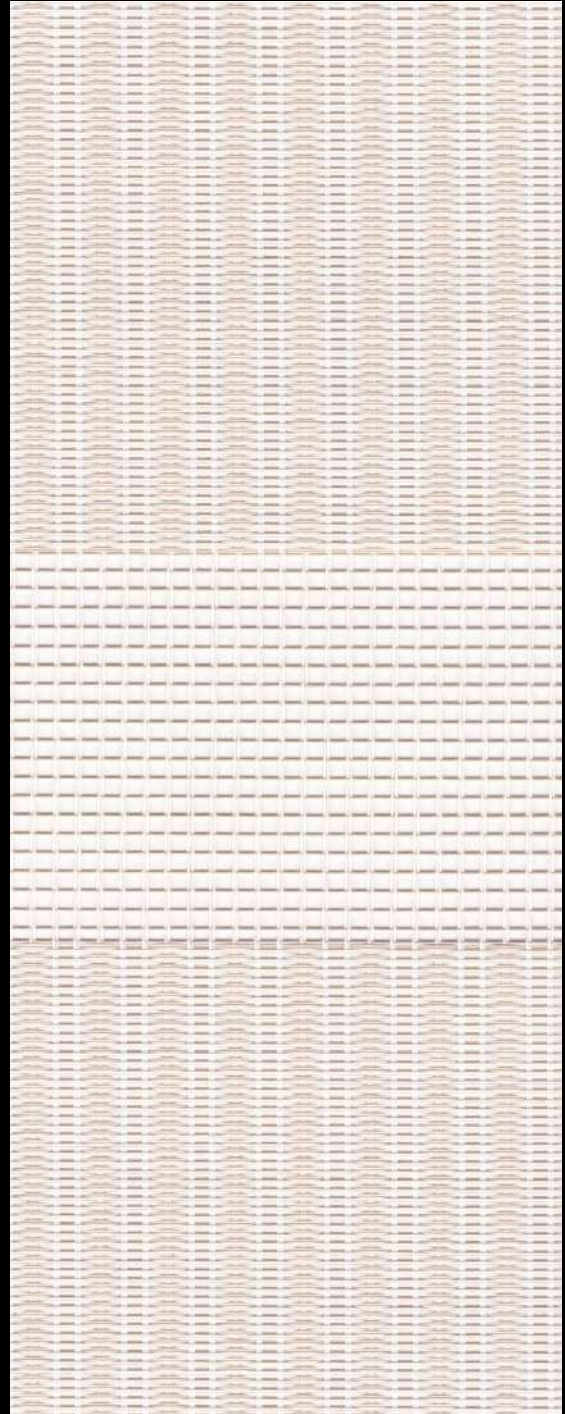

## Zebra-Screen

**White/Linen \*Flax**

DS-ZE-0326

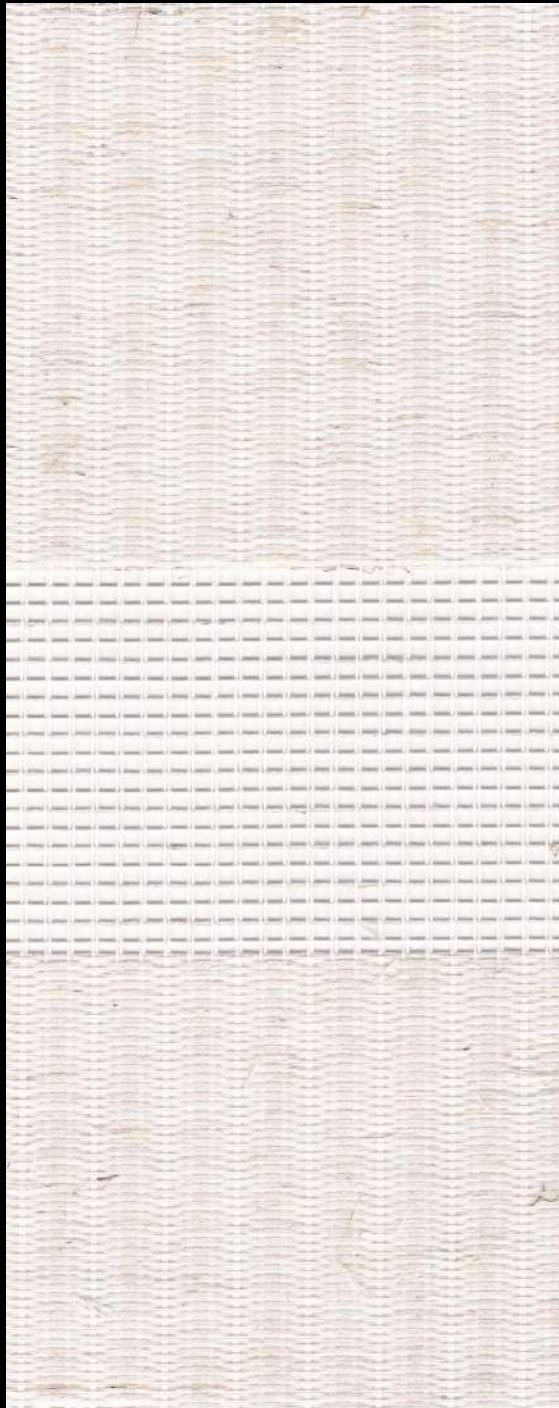

## Zebra-Screen

White

DS-TR-ZU00-0101

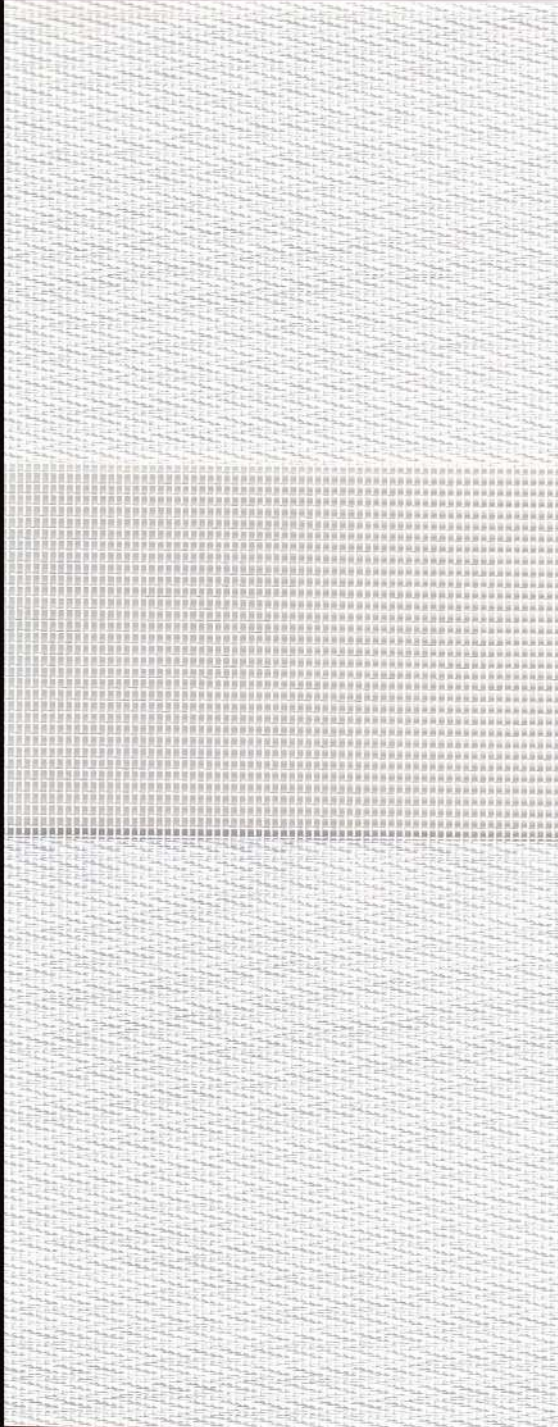

## Zebra-Screen

Linen

DS-TR-ZU00-0102

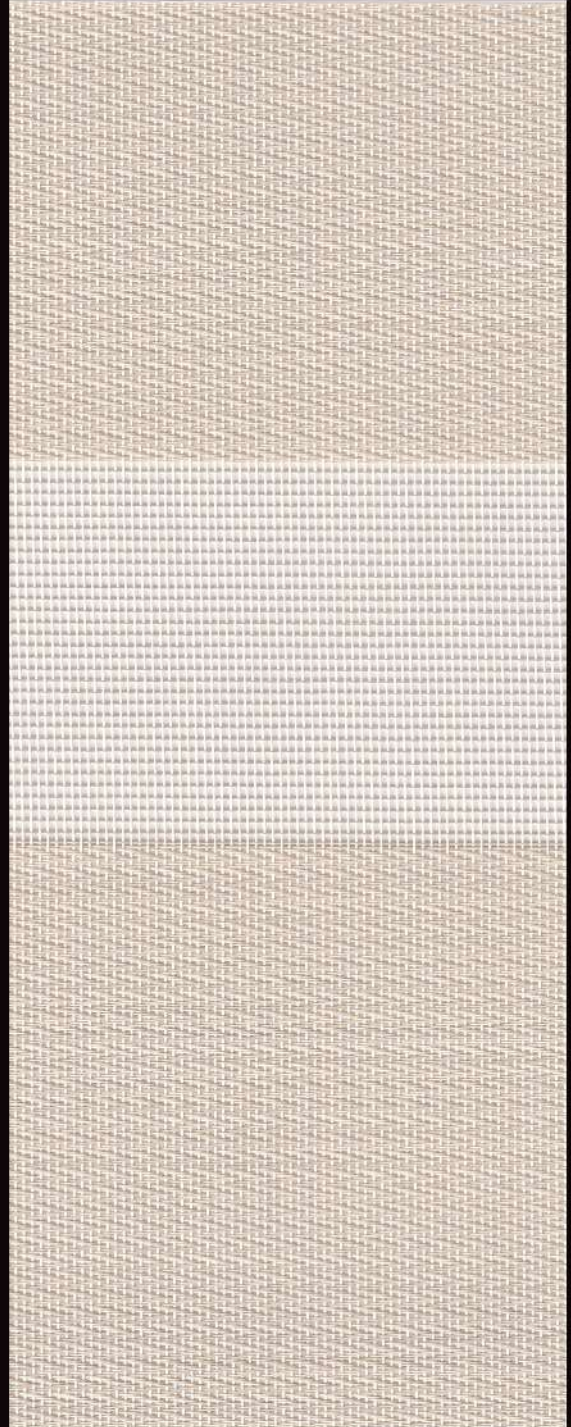

## Zebra-Screen

Grey

DS-TR-ZU00-0105

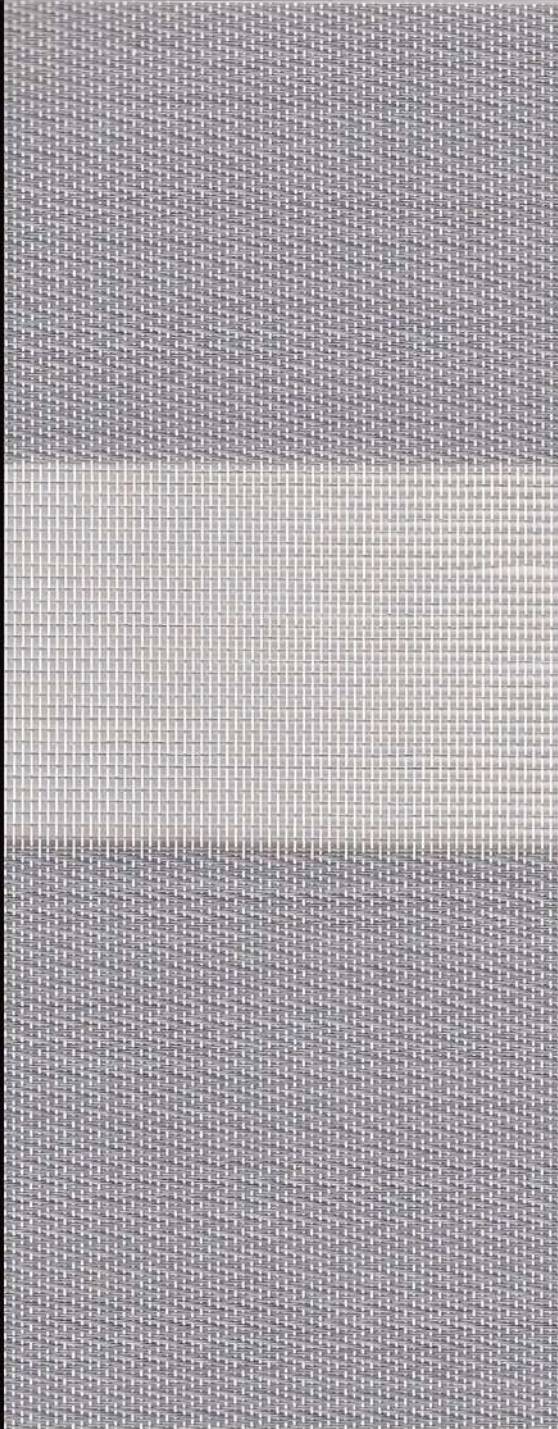

## Zebra-Screen

White

DS-TR-ZU00-0465

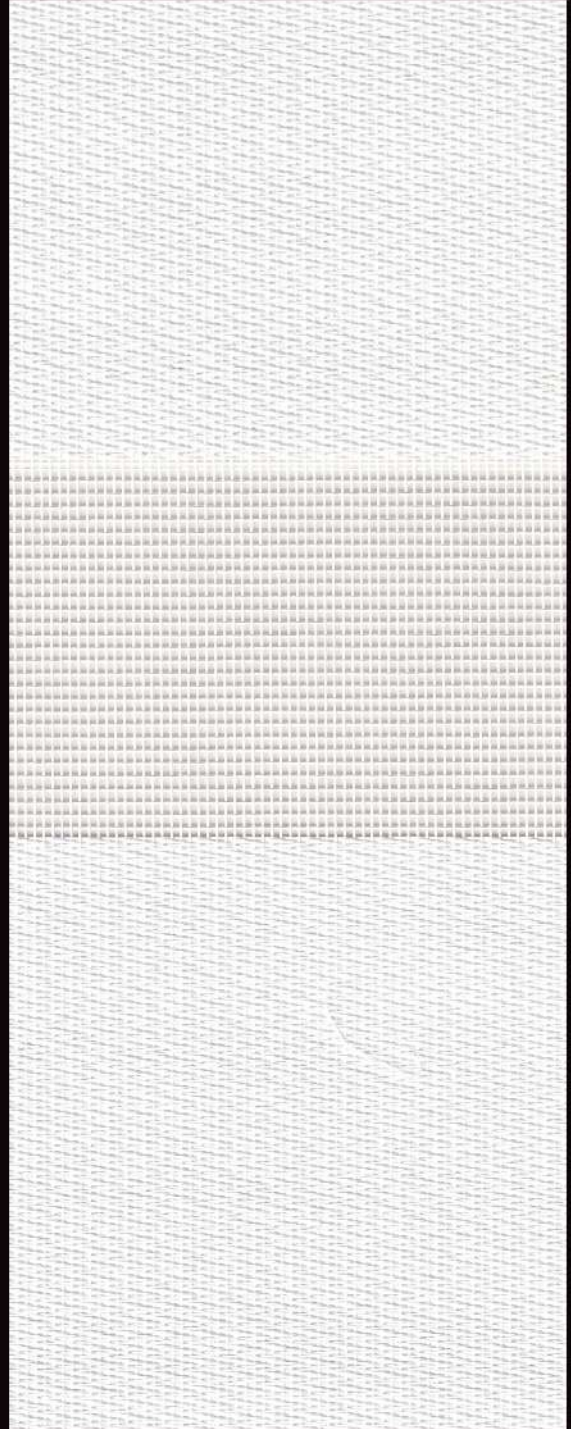

## Zebra-Screen

**Brown**

DS-TR-ZU00-0467

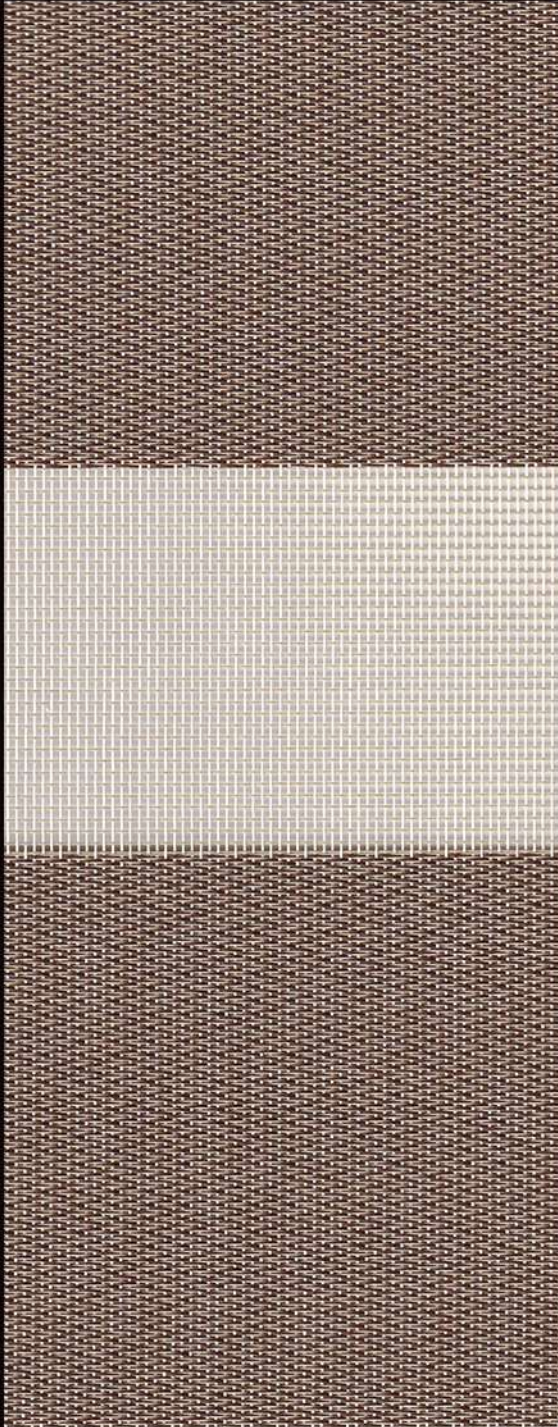

## Zebra-Screen

**Grey**

DS-TR-ZU00-0468

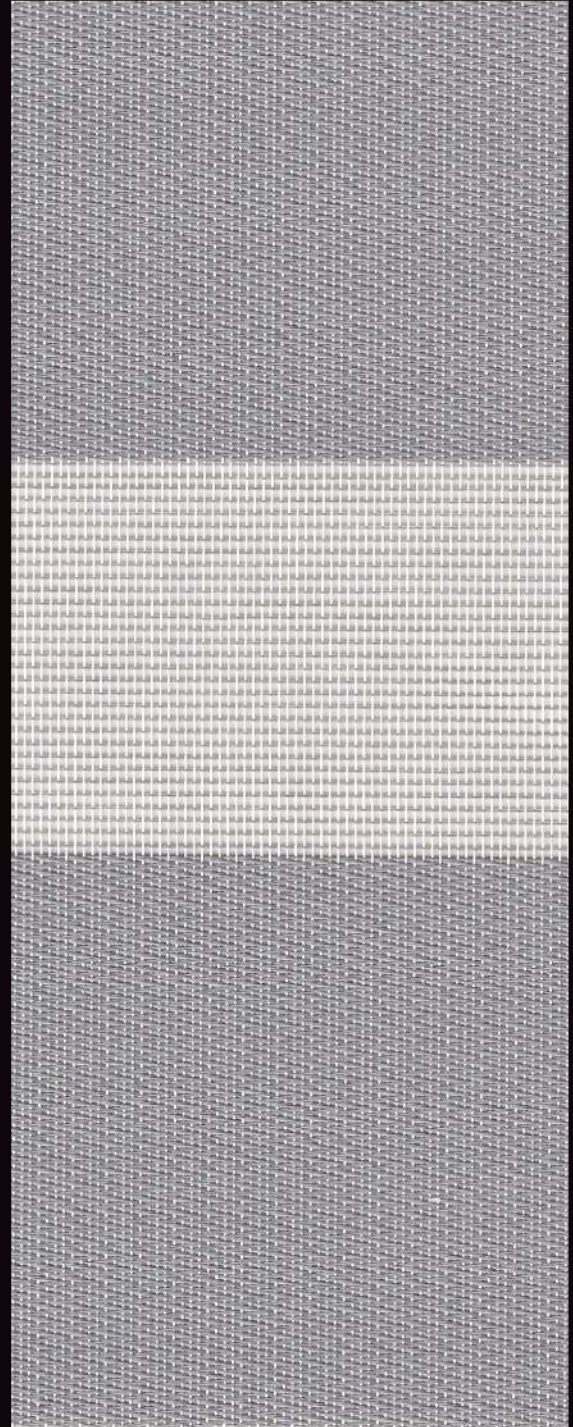

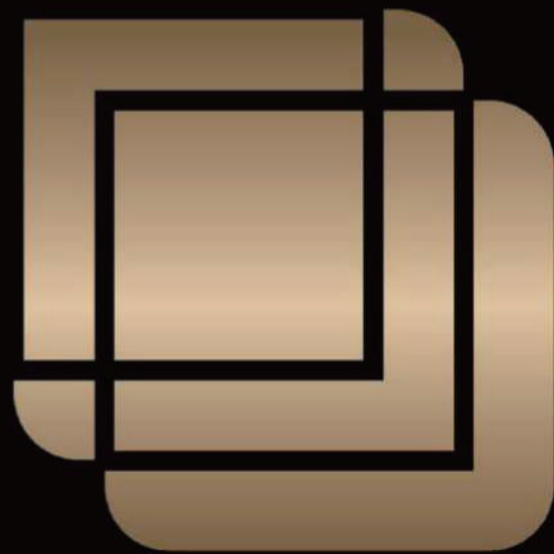

Play With Light And Heat, For Green Life

